



# HVAC ACCESSORIES

## MINNESOTA FLEXIBLE CORPORATION

305 Bridgepoint Drive #400 | South Saint Paul, MN 55075 | Tel: 651.645.7522 | 800.351.9069 | Fax: 651-645-8259 | www.mfchse.com | info@mnflex.com

PROJECT	
CUSTOMER	
ENGINEER	
REPRESENTATIVE	
DRAWING #	

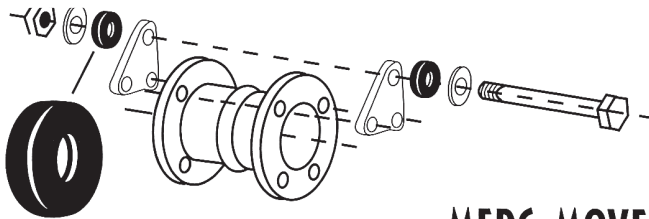
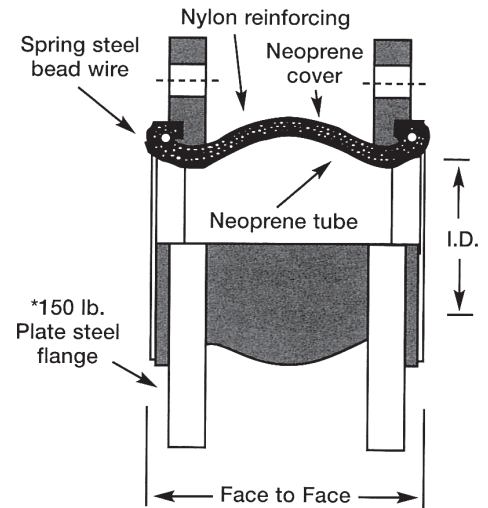

### MFRS MOVEMENTS

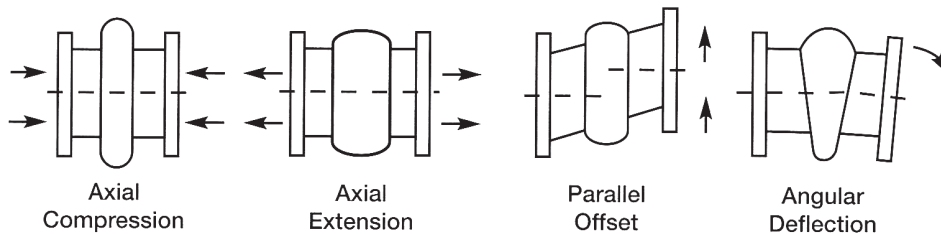

Normal Pipe Size	Neutral Length	Axial Compression	Axial Extension	Lateral Deflection (inches)	Angular Deflection (degrees)	Pressure Rating	Vacuum Rating	Weight
1.5	6	.50	.375	.50	15	213	26	6
2	6	.50	.375	.50	15	213	26	12.5
2.5	6	.50	.375	.50	15	213	26	12.5
3	6	.625	.375	.50	15	213	26	14
4	6	.625	.375	.50	15	213	26	18.5
5	6	.625	.375	.50	15	213	26	23
6	6	.625	.375	.50	15	213	26	27
8	6	.75	.375	.50	15	213	26	41
10	8	.75	.5	.75	15	213	26	57
12	8	.75	.5	.75	15	213	26	83
14	8	.75	.5	.75	15	114	26	115
16	8	.75	.5	.75	15	114	26	165
18	8	.75	.5	.75	15	114	26	168
20	8	.75	.5	.75	15	114	26	170
22	8	.75	.5	.75	15	114	26	210
24	10	.75	.5	.75	15	114	26	255

### MFRS - SINGLE SPHERE - FLANGED



# HVAC ACCESSORIES

## MINNESOTA FLEXIBLE CORPORATION

305 Bridgepoint Drive #400 | South Saint Paul, MN 55075 | Tel: 651.645.7522 | 800.351.9069 | Fax: 651-645-8259 | www.mfchse.com | info@mnflex.com

PROJECT	
CUSTOMER	
ENGINEER	
REPRESENTATIVE	
DRAWING #	

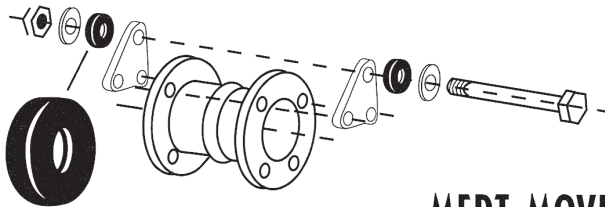
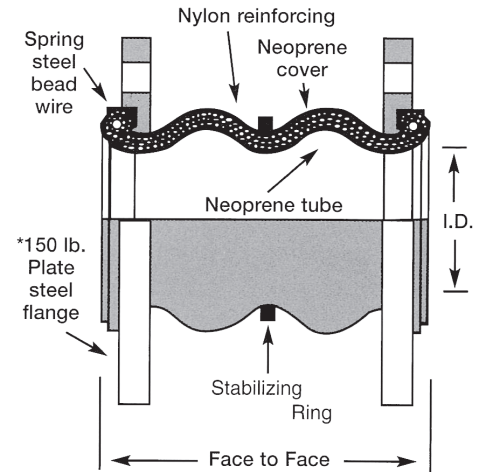

### MFRT MOVEMENTS

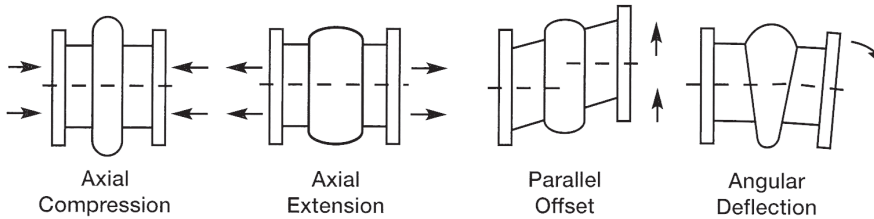

Normal Pipe Size	Neutral Length	Axial Compression	Axial Extension	Lateral Deflection (inches)	Angular Deflection (degrees)	Pressure Rating	Vacuum Rating	Weight
1.5	7	1"	.75	1"	30	213	26	7
2	7	1"	.75	1"	30	213	26	9
2.5	7	1"	.75	1"	30	213	26	13.5
3	7	1"	.75	1"	30	213	26	14.5
4	9	1.375	1"	1.25	30	213	26	20.5
5	9	1.375	1"	1.25	30	213	26	24.5
6	9	1.375	1"	1.25	30	213	26	29.5
8	13	1.75	1"	1.5	30	213	26	44
10	13	1.75	1"	1.5	30	213	26	65.5
12	13	1.75	1"	1.5	30	213	26	95
14	13.75	1.75	1.25	1.5	20	114	26	112
16	13.75	1.75	1.25	1.5	20	114	26	132
18	13.75	1.75	1.25	1.5	20	114	26	146
20	13.75	1.75	1.25	1.5	20	114	26	182
22	13.75	1.75	1.25	1.5	20	114	26	185
24	13.75	1.75	1.25	1.5	20	114	26	220

### MFRT - DOUBLE SPHERE - FLANGED



# HVAC ACCESSORIES

## MINNESOTA FLEXIBLE CORPORATION

305 Bridgepoint Drive #400 | South Saint Paul, MN 55075 | Tel: 651.645.7522 | 800.351.9069 | Fax: 651-645-8259 | www.mfchose.com | info@mnflex.com

PROJECT	
CUSTOMER	
ENGINEER	
REPRESENTATIVE	
DRAWING #	

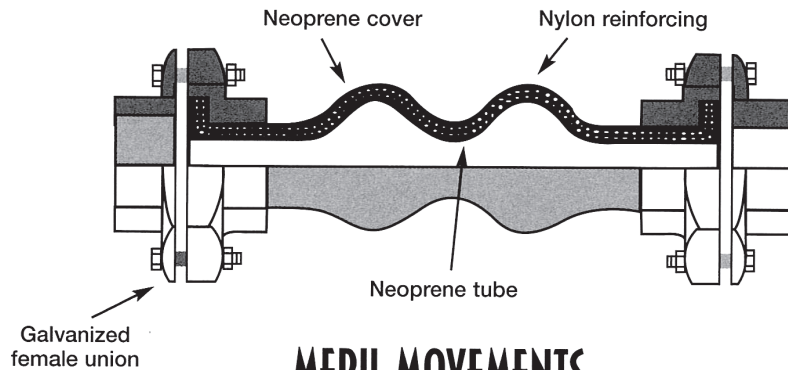

### MFRU MOVEMENTS

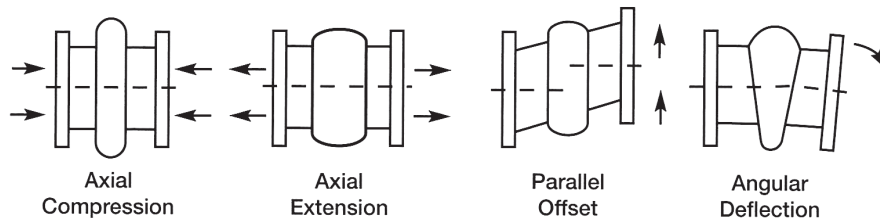

Normal Pipe Size	Face to Face	Axial Compression	Axial Extension	Angular Deflection (degrees)	Pressure Rating	Weight
.75	8	.88	.25	45	150	1.8
1	8	.88	.25	45	150	2.75
1.25	8	.88	.25	45	150	3.5
1.50	8	.88	.25	45	150	4
2	8	.88	.25	45	150	5

## MFRU - DOUBLE SPHERE - UNIONS